

SK 45 STA

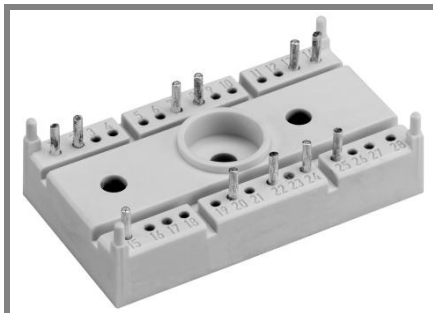

SEMITOP® 3

Six Separated Thyristors Module

SK 45 STA

Preliminary Data

Features

- Compact design
- One screw mounting
- Heat transfer and isolation through direct copper bonded aluminium oxide ceramic (DCB)
- Glass passivated thyristor chips
- Up to 1600 V reverse voltage

Typical Applications

- Soft starters
- Light control (studios, theatres...)
- Temperature control

V_{RSM} V	V_{RRM}, V_{DRM} V	$I_{TRMS} = 41$ A ($T_s = 75$ °C)
900	800	SK 45 STA 08
1300	1200	SK 45 STA 12
1700	1600	SK 45 STA 16

Characteristics		$T_h = 25$ °C, unless otherwise specified	
Symbol	Conditions	Values	Units
I_{rms} (W1C)	sin. 180°; $T_s = 100$ °C	33	A
I_{rms} (W1C)	sin. 180°; $T_s = 85$ °C	47	A
			A
I_{TSM}/I_{FSM}	$T_{vj} = 25$ (125) °C; 10 ms	450 (380)	A
I^2t	$T_{vj} = 25$ (125) °C; 8,3 ... 10 ms ms	1000 (720)	A²s
T_{stg}		- 40 ... + 125	°C
T_{solder}	terminals, 10 s	260	°C
Thyristor			
$(dv/dt)_{cr}$	$T_{vj} = 125$ °C	1000	V/μs
$(di/dt)_{cr}$	$T_{vj} = 125$ °C; $f = 50 \dots 60$ Hz	50	A/μs
t_q	$T_{vj} = 125$ °C; typ.	80	μs
I_H	$T_{vj} = 25$ °C; typ. / max.	80 / 150	mA
I_L	$T_{vj} = 25$ °C; $R_G = 33$ Ω; typ. / max.	150 / 300	mA
V_T	$T_{vj} = 25$ °C; ($I_T = 75$ A); max.	1,9	V
$V_{T(TO)}$	$T_{vj} = 125$ °C	max. 1	V
r_T	$T_{vj} = 125$ °C	max. 10	mΩ
I_{DD}, I_{RD}	$T_{vj} = 125$ °C; $V_{DD} = V_{DRM}, V_{RD} = V_{RRM}$	max. 10	mA
$R_{th(j-s)}$		1,2	K/W
T_{vj}		- 40 ... + 125	°C
V_{GT}	$T_{vj} = 25$ °C; d.c.	3	V
I_{GT}	$T_{vj} = 25$ °C; d.c.	100	mA
V_{GD}	$T_{vj} = 125$ °C; d.c.	0,25	V
I_{GD}	$T_{vj} = 125$ °C; d.c.	3	mA
Diode			
V_F	$T_{vj} =$ °C; ($I_F = A$); max.		V
$V_{(TO)}$	$T_{vj} =$ °C		V
r_T	$T_{vj} =$ °C		mΩ
I_{RD}	$T_{vj} =$ °C; $V_{RD} = V_{RRM}$		mA
$R_{th(j-s)}$			K/W
T_{vj}			°C
Mechanical data			
V_{isol}	a.c. 50 Hz; r.m.s.; 1 min / 1s	2500 (3000)	V
M_1	mounting torque	2,5	Nm
w		30	g
Case	SEMITOP® 3	T56	

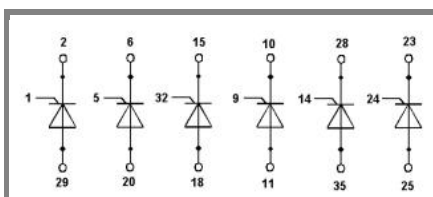

STA

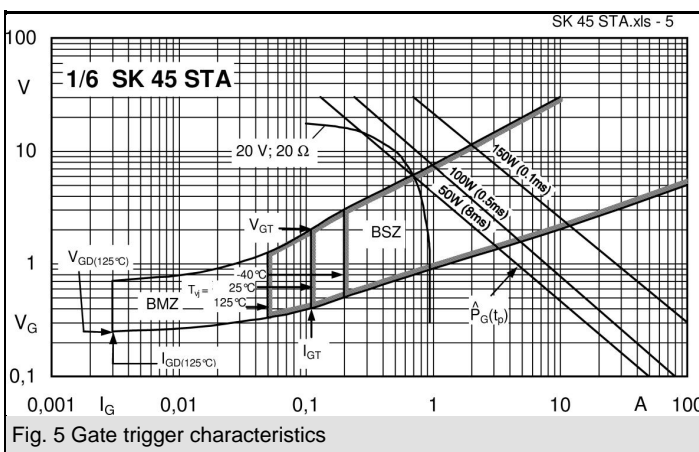
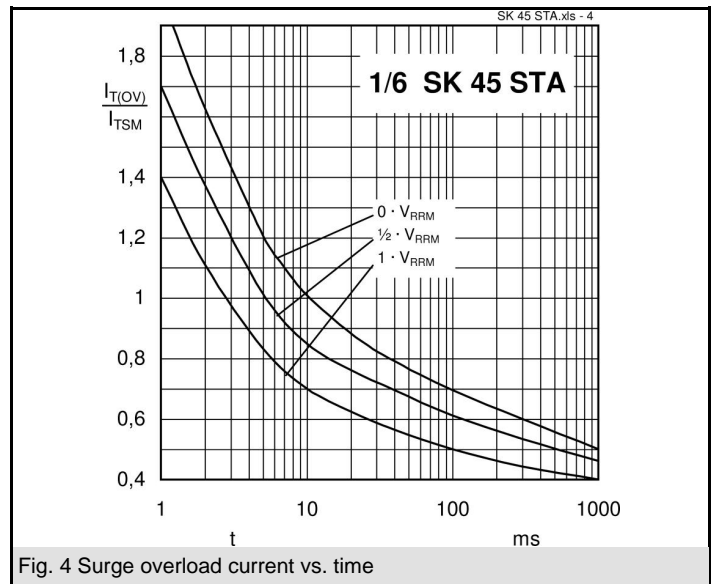
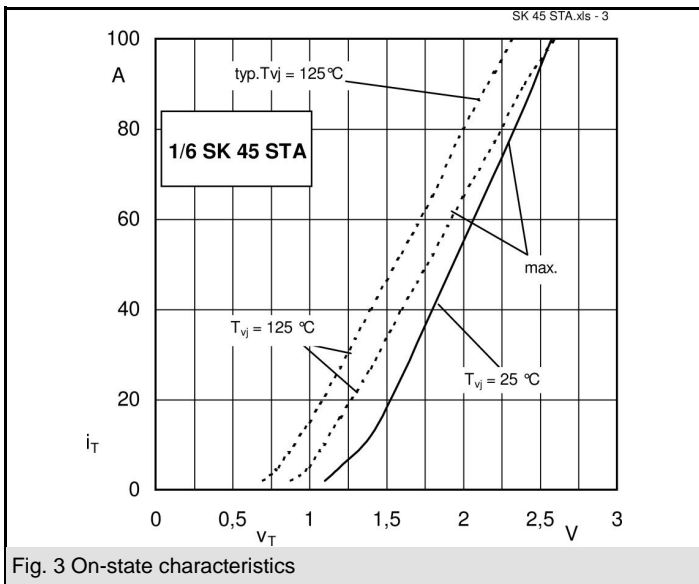
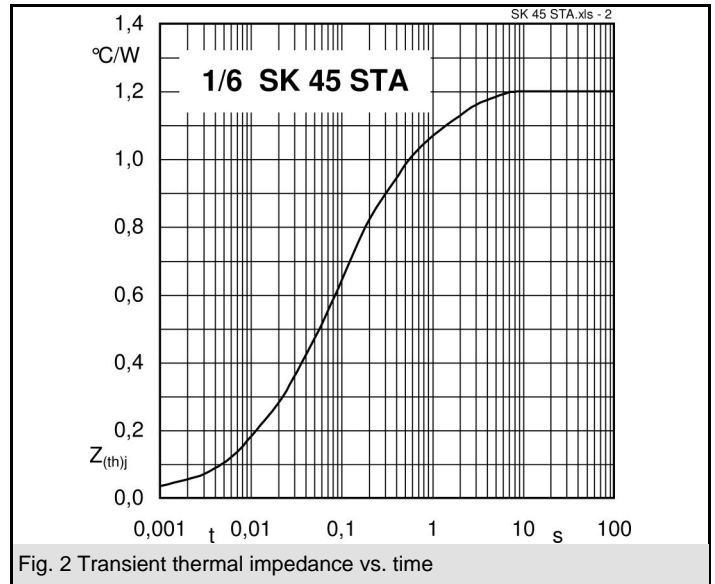
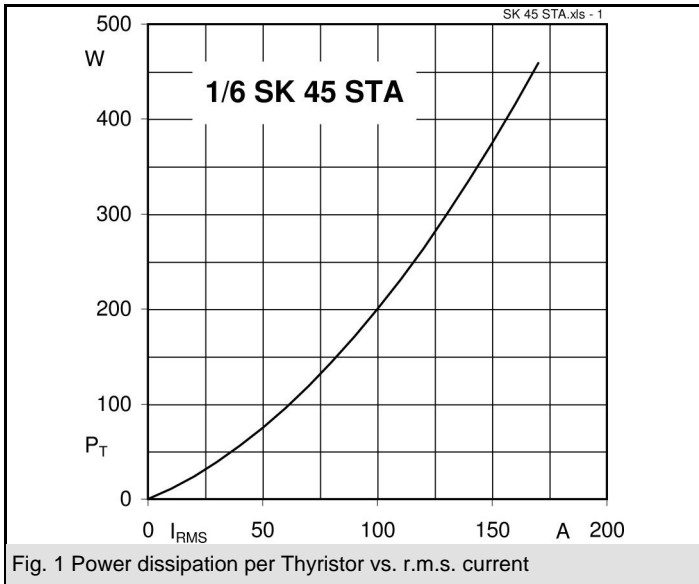

SK 45 STA

UL Recognized
File no. E 63532

Dimensions in mm

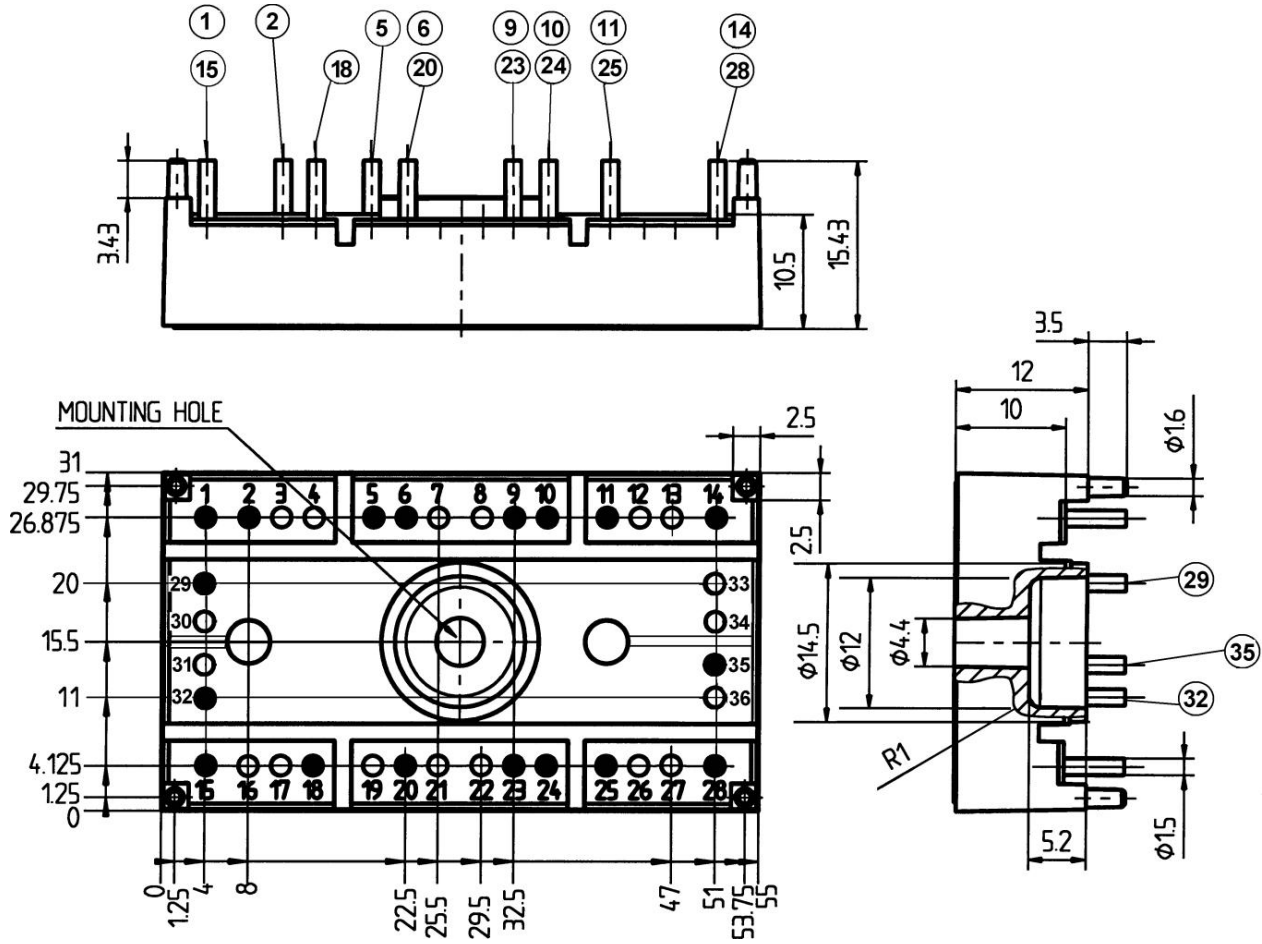

SUGGESTED HOLEDIAMETER FOR THE SOLDER PINS AND THE MOUNTING PINS IN THE PCB: 2 mm

Case T56 (Suggested hole diameter in the PCB for solder pins and mounting pins: 2mm)

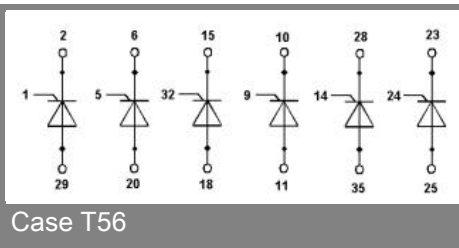

Case T56

This is an electrostatic discharge sensitive device (ESDS), international standard IEC 60747-1, Chapter IX.

This technical information specifies semiconductor devices but promises no characteristics. No warranty or guarantee expressed or implied is made regarding delivery, performance or suitability.