



**SEMIPACK® 3**

## Rectifier Diode Modules

### SKKD 380

#### Features

- Heat transfer through aluminium nitride ceramic isolated metal baseplate
- Precise metal pressure contacts for high reliability
- UL recognized, file no. E 63 532

#### Typical Applications

- Uncontrolled rectifiers for AC/AC converters
- Line rectifiers for transistorized AC motor controllers
- Field supply for DC motors

1) The screws must be lubricated

$V_{RSM}$ V	$V_{RRM}$ V	$I_{FRMS} = 600$ A (maximum value for continuous operation) $I_{FAV} = 380$ A (sin. 180; $T_c = 100$ °C)	
900	800	SKKD 380/08	
1300	1200	SKKD 380/12	
1700	1600	SKKD 380/16	
1900	1800	SKKD 380/18	
2100	2000	SKKD 380/20H4	
2300	2200	SKKD 380/22H4	

Symbol	Conditions	Values	Units
$I_{FAV}$	sin. 180; $T_c = 100$ °C	380	A
$I_{FSM}$	$T_{vj} = 25$ °C; 10 ms	11000	A
	$T_{vj} = 150$ °C; 10 ms	10000	A
$i^2t$	$T_{vj} = 25$ °C; 8,3 ... 10 ms	605000	A <sup>2</sup> s
	$T_{vj} = 150$ °C; 8,3 ... 10 ms	500000	A <sup>2</sup> s
$V_F$	$T_{vj} = 25$ °C; $I_F = 1000$ A	max. 1,25	V
$V_{(TO)}$	$T_{vj} = 150$ °C	max. 0,8	V
$r_T$	$T_{vj} = 150$ °C	max. 0,35	mΩ
$I_{RD}$	$T_{vj} = 150$ °C; $V_{RD} = V_{RRM}$	max. 15	mA
$R_{th(j-c)}$	cont. per diode / per module sin. 180 per diode / per module	0,11 / 0,055 0,116 / 0,058	K/W K/W
$R_{th(c-s)}$	per diode / per module	0,04 / 0,02	K/W
$T_{vj}$		- 40 ... + 150	°C
$T_{stg}$		- 40 ... + 130	°C
$V_{isol}$	a. c. 50 Hz; r.m.s.; 1 s / 1 min.	3600 / 3000	V~
$V_{isol}$	a. c. 50 Hz; r.m.s.; 1 s / 1 min. for SKK ...H4	4800 / 4000	V~
$M_s$	to heatsink	5 ± 15 %	Nm
$M_t$	to terminals	9 ± 15 % <sup>1)</sup>	Nm
$a$		5 * 9,81	m/s <sup>2</sup>
$m$	approx.	600	g
Case		A 78b	



**SKKD**

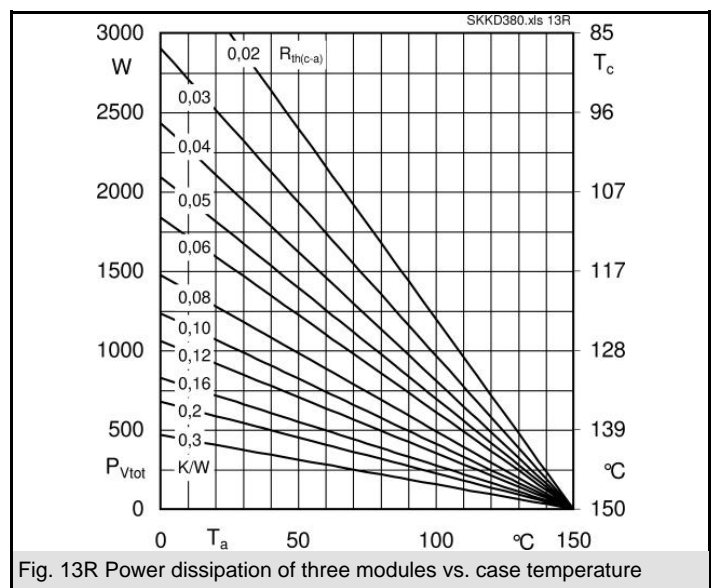
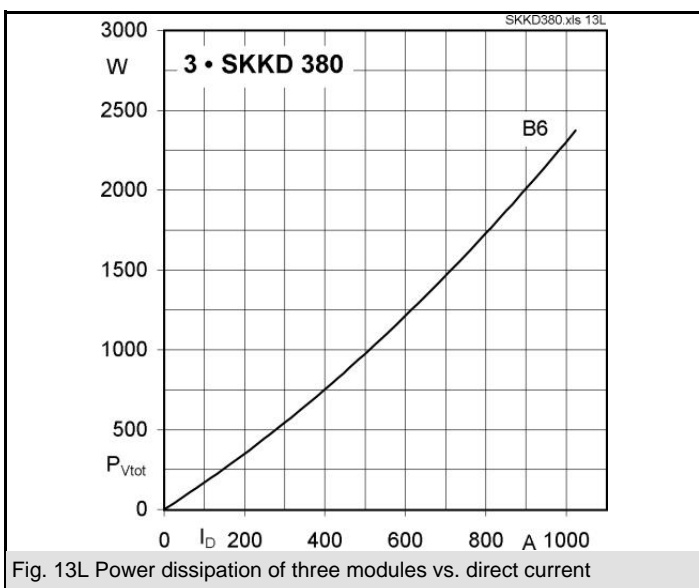
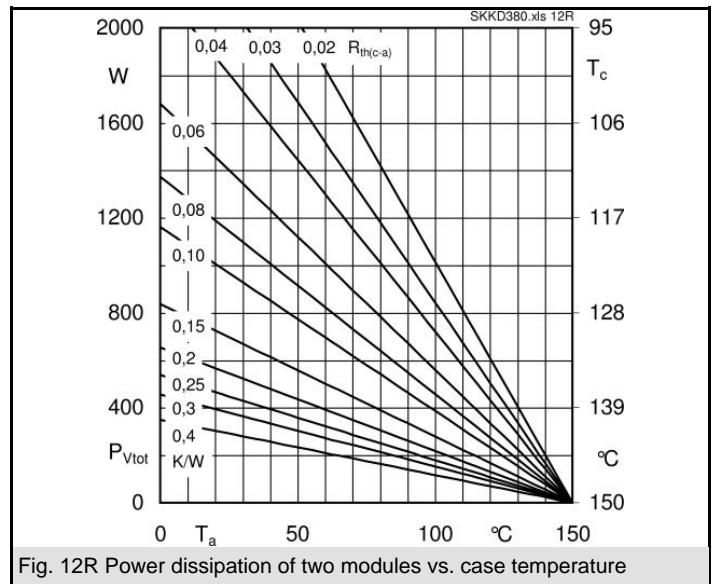
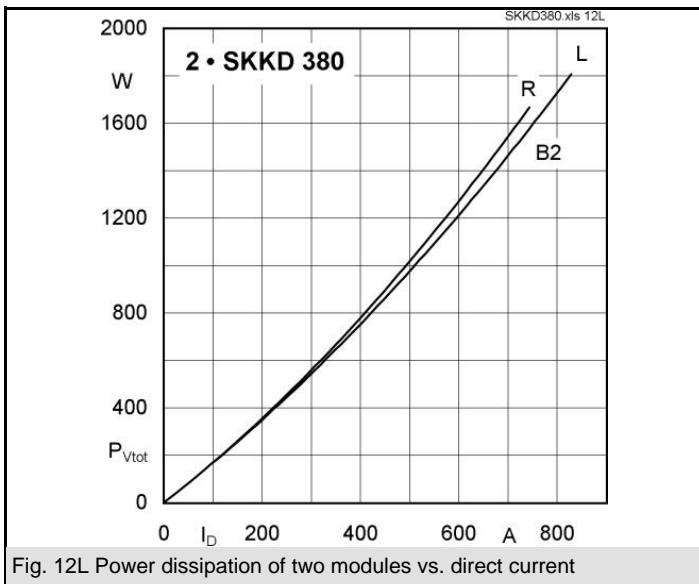
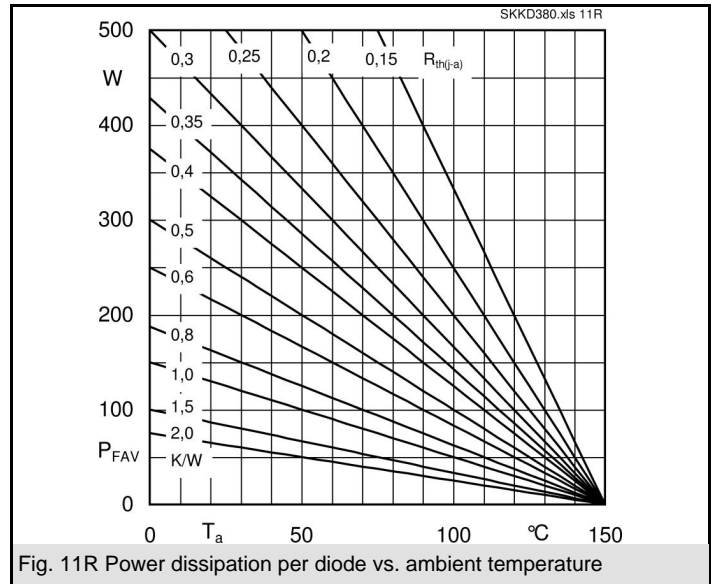
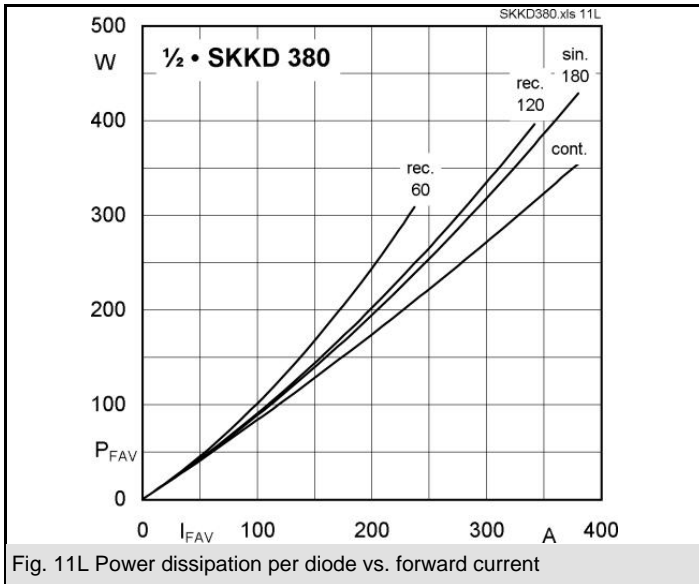

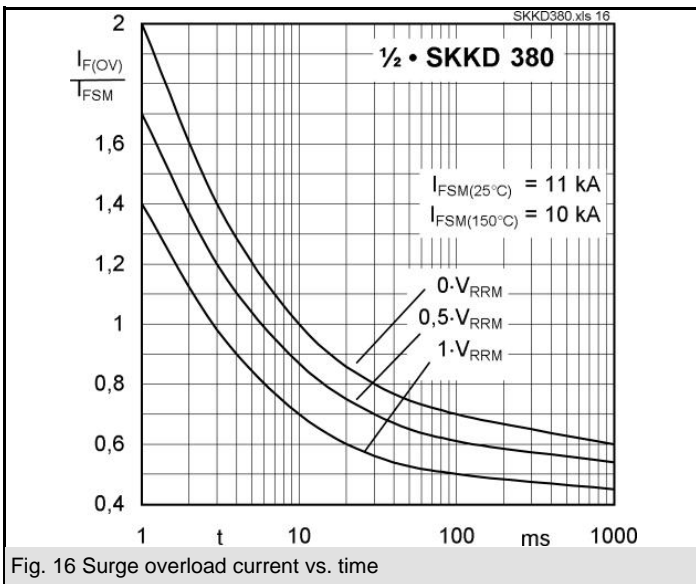
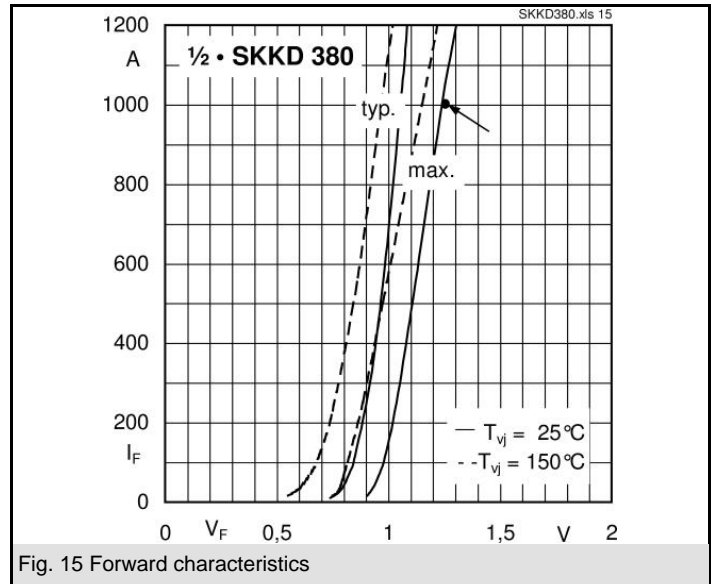
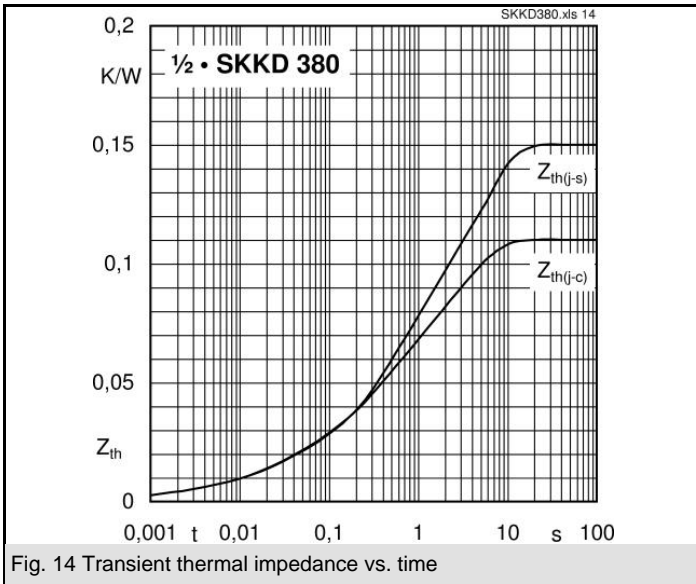

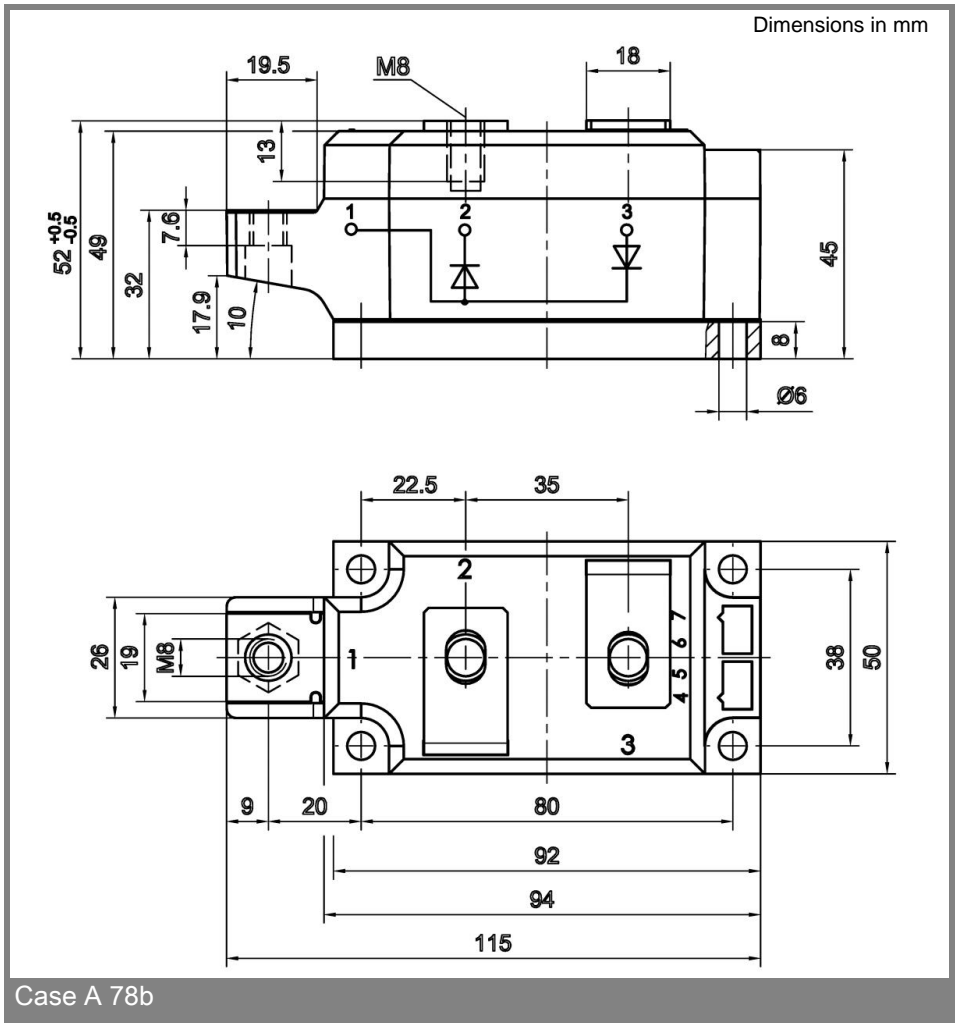

This technical information specifies semiconductor devices but promises no characteristics. No warranty or guarantee expressed or implied is made regarding delivery, performance or suitability.