

SKKT 460, SKKH 460



SEMIPACK[®] 5

Thyristor / Diode Modules

SKKT 460

SKKH 460

Features

- Heat transfer through aluminium nitride ceramic insulated metal baseplate
- Precious metal pressure contacts for high reliability
- UL recognized, file no. E63532

Typical Applications*

- AC motor softstarters
- Input converters for AC inverter drives
- DC motor control (e.g. for machine tools)
- Temperature control (e.g. for ovens, chemical processes)
- Professionals light dimming (studios, theaters)

1) see assembly instructions

V_{RSM} V	V_{RRM}, V_{DRM} V	$I_{TRMS} = 800$ A (maximum value for continuous operation) $I_{TAV} = 460$ A (sin. 180; $T_c = 85$ °C)	
1700	1600	SKKT 460/16E	SKKH 460/16E
2100	2000	SKKT 460/20E H4	SKKH 460/20E H4
2300	2200	SKKT 460/22E H4	SKKH 460/22E H4

Symbol	Conditions	Values	Units
I_{TAV}	sin. 180; $T_c = 85$ (100) °C;	460 (335)	A
I_{TSM}	$T_{vj} = 25$ °C; 10 ms $T_{vj} = 130$ °C; 10 ms	18000 15500	A A
i^2t	$T_{vj} = 25$ °C; 8,3 .. 10 ms $T_{vj} = 130$ °C; 8,3 ... 10 ms	1620000 1200000	A ² s A ² s
V_T	$T_{vj} = 25$ °C; $I_T = 1400$ A	max. 1,6	V
$V_{T(TO)}$	$T_{vj} = 130$ °C	max. 0,88	V
r_T	$T_{vj} = 130$ °C	max. 0,45	mΩ
I_{DD}, I_{RD}	$T_{vj} = 130$ °C; $V_{RD} = V_{RRM}; V_{DD} = V_{DRM}$	max. 240	mA
t_{gd}	$T_{vj} = 25$ °C; $I_G = 1$ A; $di_G/dt = 1$ A/μs	1	μs
t_{gr}	$V_D = 0,67 * V_{DRM}$	2	μs
$(di/dt)_{cr}$	$T_{vj} = 130$ °C	max. 250	A/μs
$(dv/dt)_{cr}$	$T_{vj} = 130$ °C	max. 1000	V/μs
t_q	$T_{vj} = 130$ °C,	100 .. 200	μs
I_H	$T_{vj} = 25$ °C; typ. / max.	150 / 500	mA
I_L	$T_{vj} = 25$ °C; $R_G = 33$ Ω; typ. / max.	300 / 2000	mA
V_{GT}	$T_{vj} = 25$ °C; d.c.	min. 3	V
I_{GT}	$T_{vj} = 25$ °C; d.c.	min. 200	mA
V_{GD}	$T_{vj} = 130$ °C; d.c.	max. 0,25	V
I_{GD}	$T_{vj} = 130$ °C; d.c.	max. 10	mA
$R_{th(j-c)}$	cont.; per thyristor / per module	0,072 / 0,035	K/W
$R_{th(j-c)}$	sin. 180°; per thyristor / per module	0,074 / 0,037	K/W
$R_{th(j-c)}$	rec. 120°; per thyristor / per module	0,078 / 0,039	K/W
$R_{th(c-s)}$	per thyristor / per module	0,02 / 0,01	K/W
T_{vj}		- 40 ... + 130	°C
T_{stg}		- 40 ... + 125	°C
V_{isol}	a.c. 50 Hz; r.m.s.; 1 s / 1 min.	3600 / 3000	V~
V_{isol}	a.c. 50 Hz; r.m.s.; 1 s / 1 min. for SKK...H4	4800 / 4000	V~
M_s	to heatsink	5 ± 15% ¹⁾	Nm
M_t	to terminals	12 ± 15%	Nm
a		5 * 9,81	m/s ²
m	approx.	1400	g
Case	SKKT SKKH	A 60b A 66b	



SKKT

SKKH

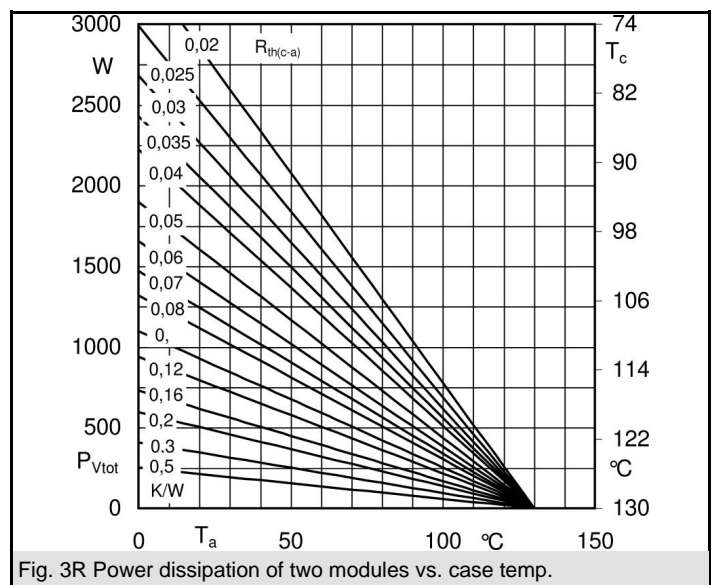
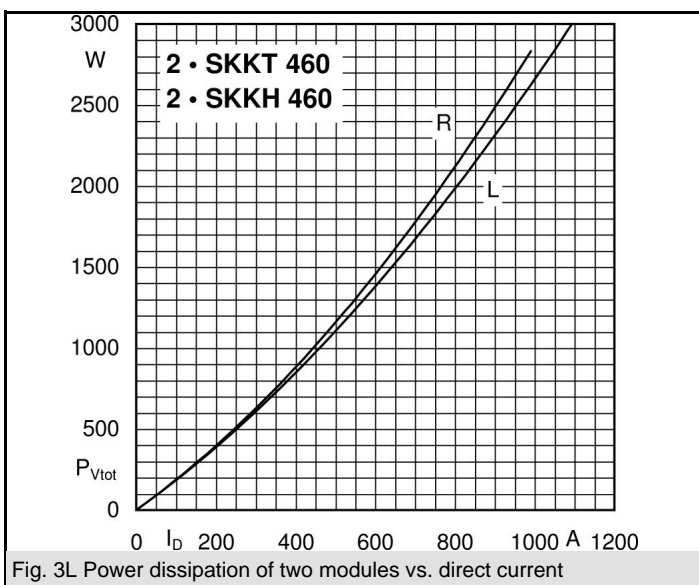
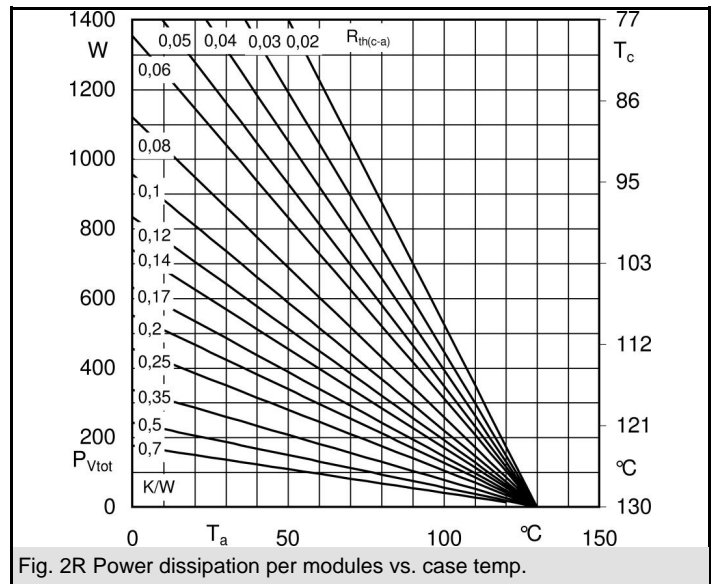
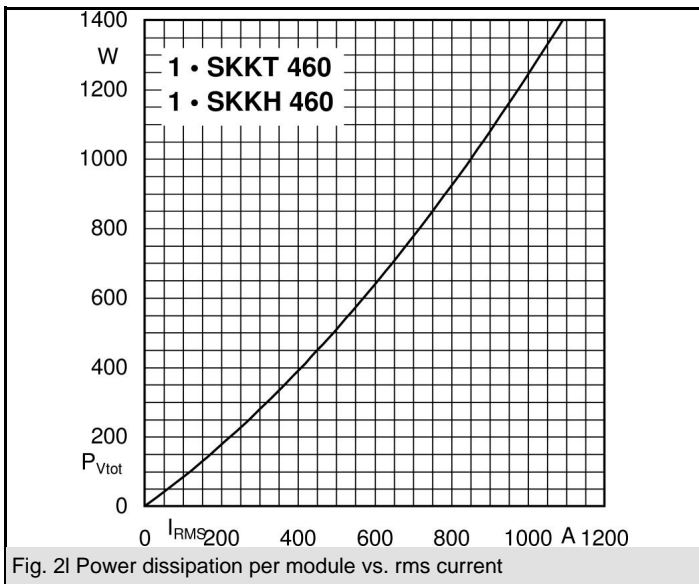
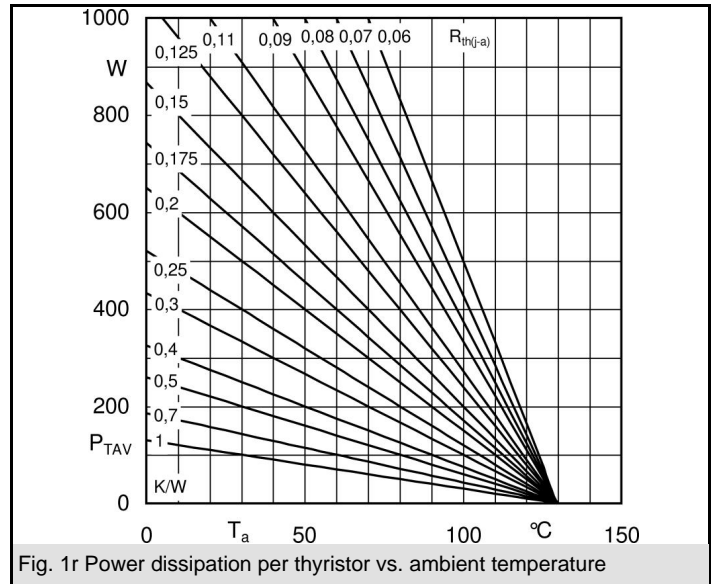
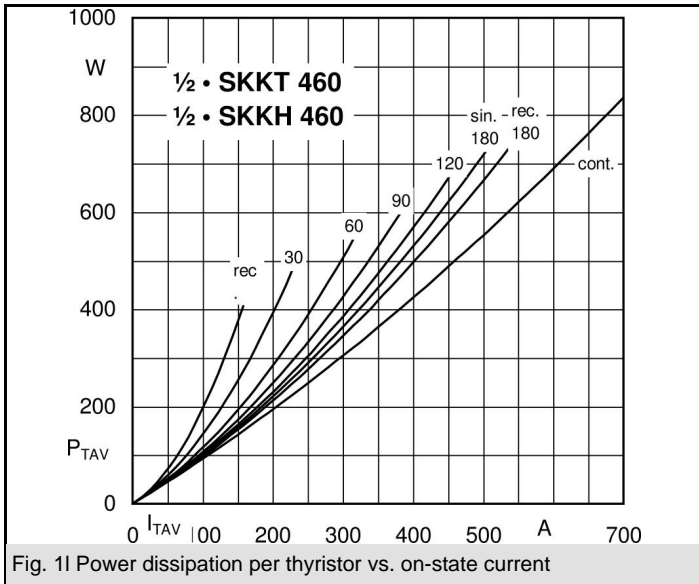

SKKT 460, SKKH 460

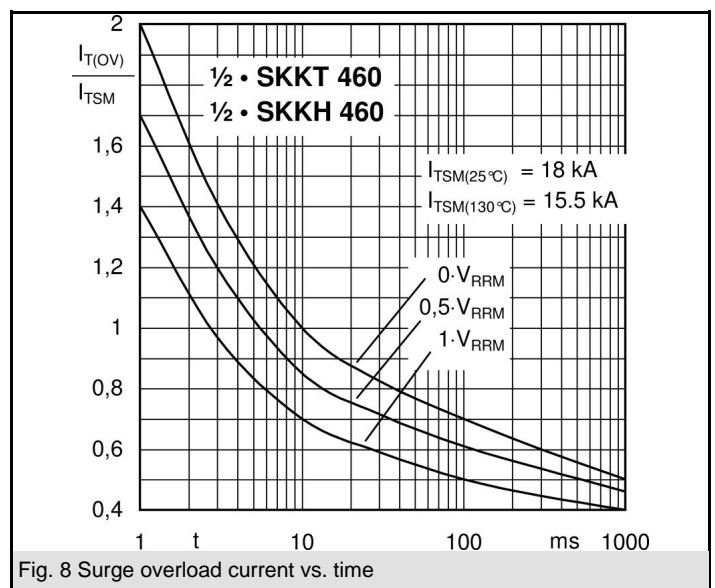
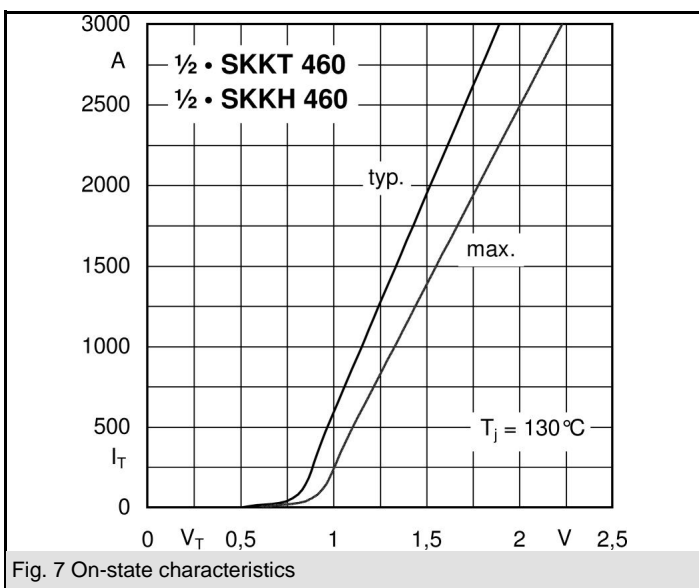
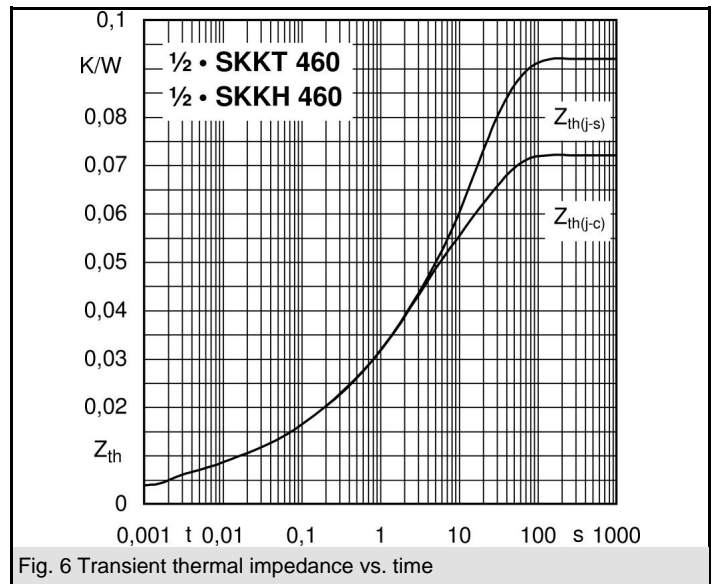
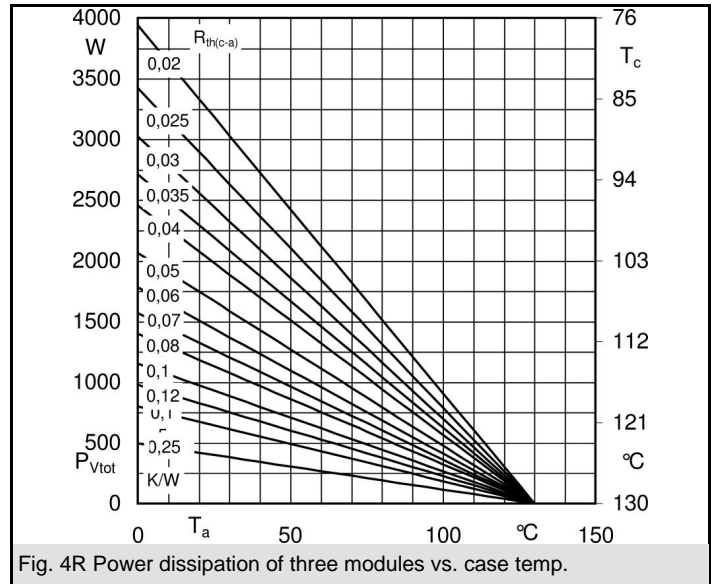
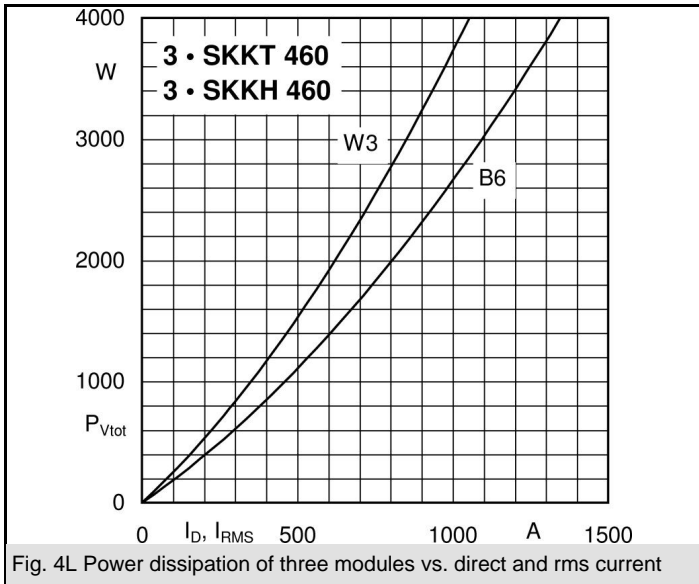

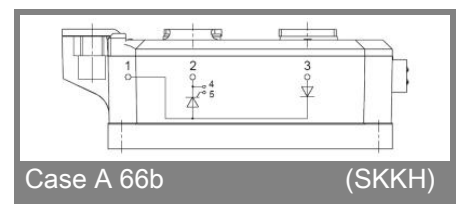
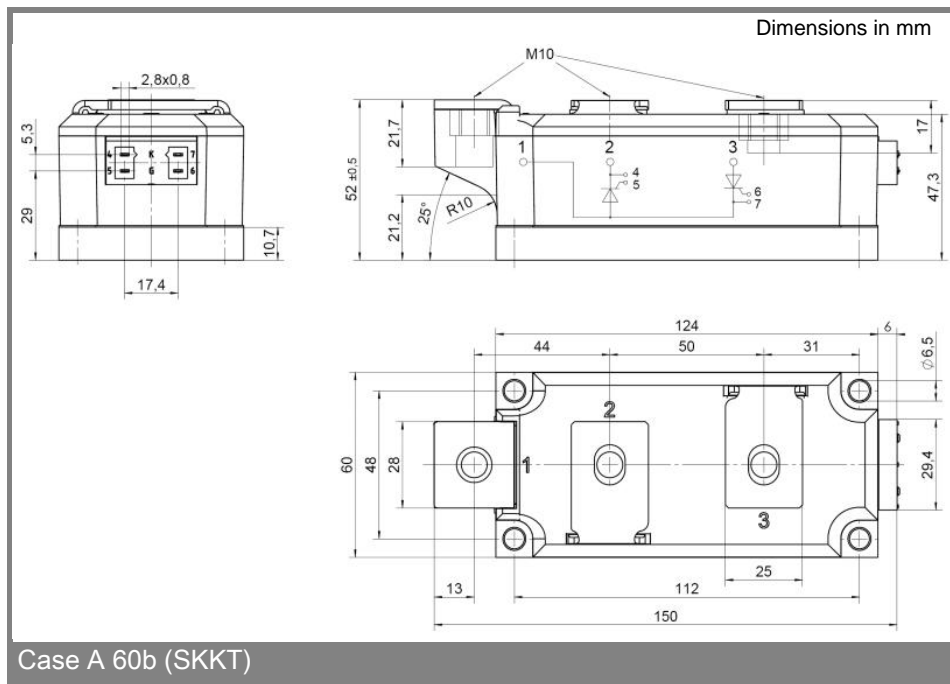
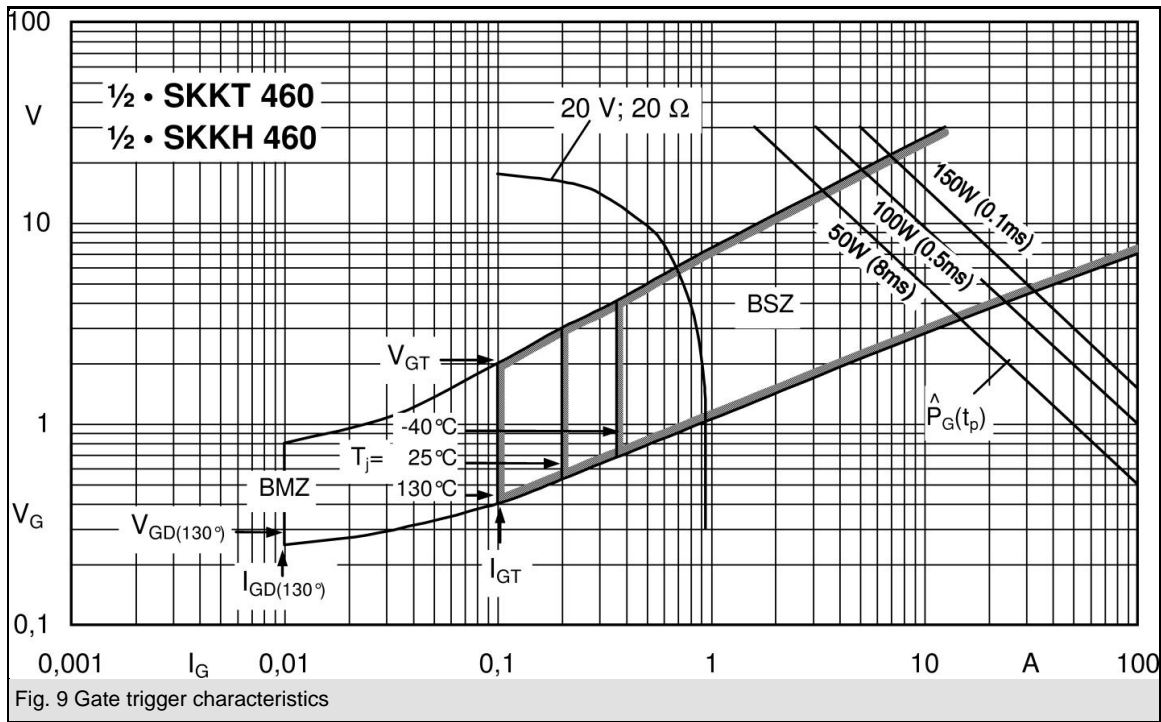

* The specifications of our components may not be considered as an assurance of component characteristics. Components have to be tested for the respective application. Adjustments may be necessary. The use of SEMIKRON products in life support appliances and systems is subject to prior specification and written approval by SEMIKRON. We therefore strongly recommend prior consultation of our staff.